

Coding Express

Screen Free • Smart Control • Safe Play

Instruction manual

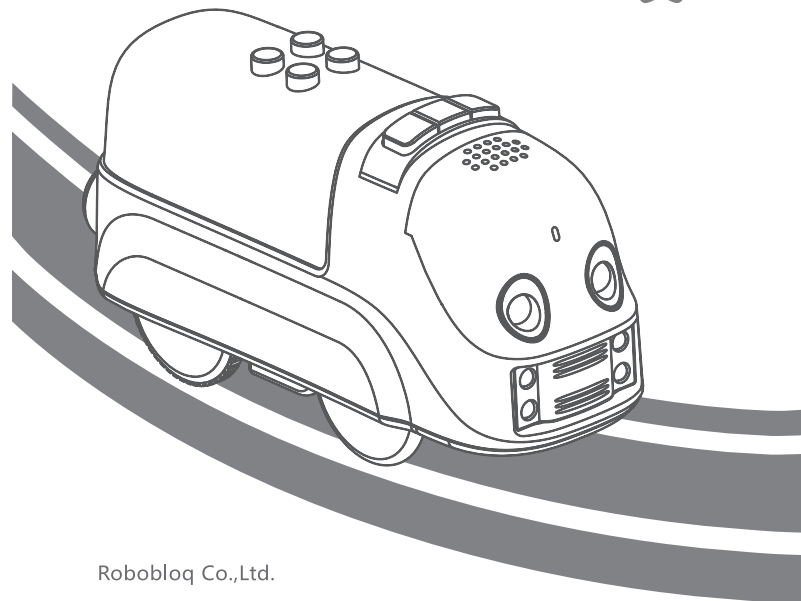

Product Description

Coding Express is a color-programmable robotic toy train designed for preschoolers over 3 years old. Rich in interactive entertainment value and educational functions, Coding Express is suitable for both parent-child interaction in the family and educational settings.

As it is equipped with a Track Mode and a Free Mode, the product can be enjoyed both on the track and off the track. It supports various functions including operational control, music playback, intelligent tracking, and intelligent obstacle avoidance through multiple built-in sensors and inductive stickers, which allow children to assemble tracks freely, to add and remove blocks on the body of robot train, or use colored stickers to discover more interesting styles of gameplay and tasks to perform. The product is eye-friendly and safe without any digital screens. It creates an immersive experience through scenario-based games, so that children can improve their concentration, hands-on ability, creativity, logical thinking, and social skills during the process of playing.

Product List

24 Wooden tracks, 1 Robot train, 4 Action stickers,
1 Manual.

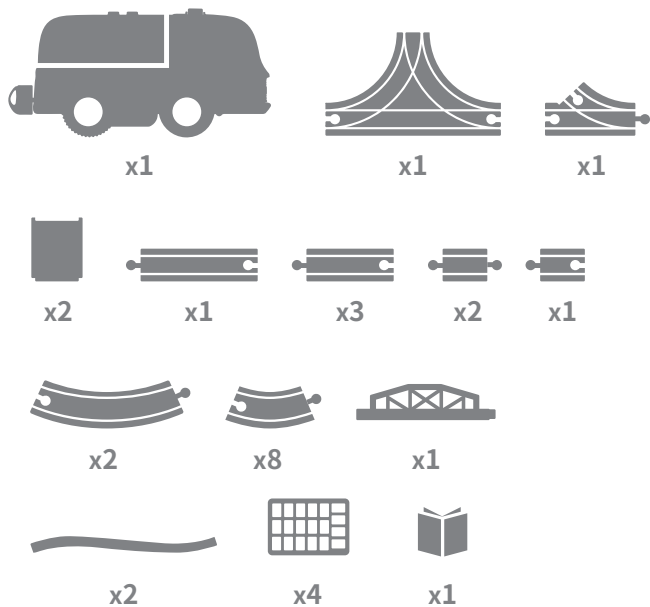

02

Product Display

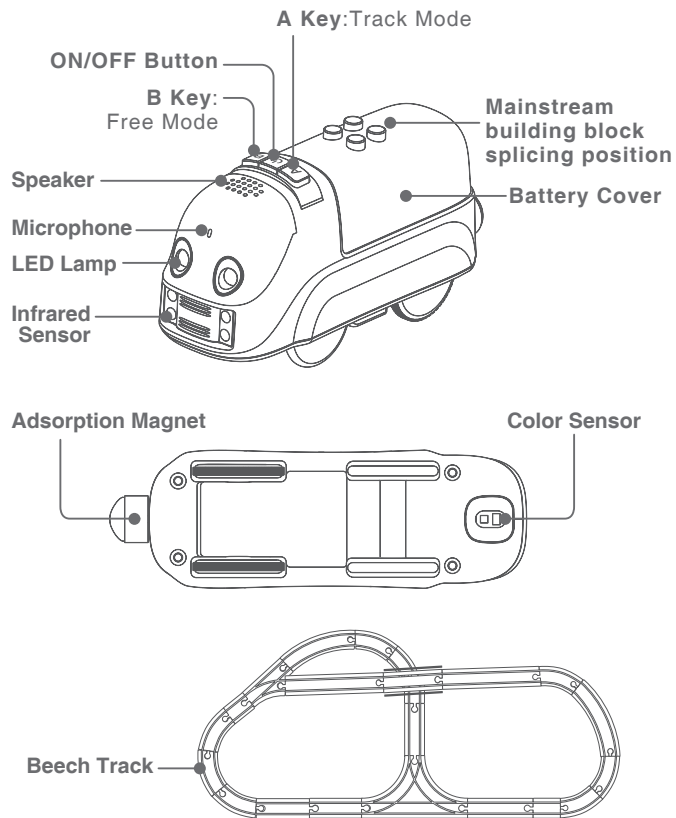

03

Instructions

1) Install Batteries

The battery must be installed before use. Loosen the screws with a screwdriver, open the battery cover and insert 3*AAA batteries, then close the battery cover and tighten the screws.

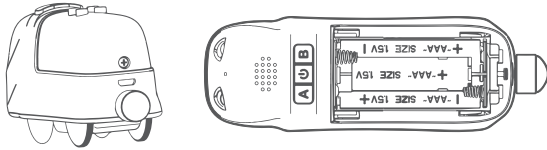

2) Gameplay Description

The product supports two modes: Track mode and Free mode. After Track mode is enabled, the robot train will enter a state of movement. After Free mode is enabled, the robot train will remain stationary.

1. Track Mode

The train tracks need to be built by parents or children.

Standard Assembly

Assemble the tracks together as shown in the diagram, turn on the robot train, and switch to Track mode by pressing the A key. Then, place it on the track for operation.

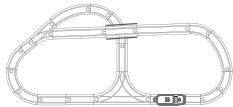



- 1** Press the on/off button. You will hear a sound when it is successfully started.
- 2** Then press the A key to enable Track mode and the train will start to run.

Instructions for splicing of train tracks

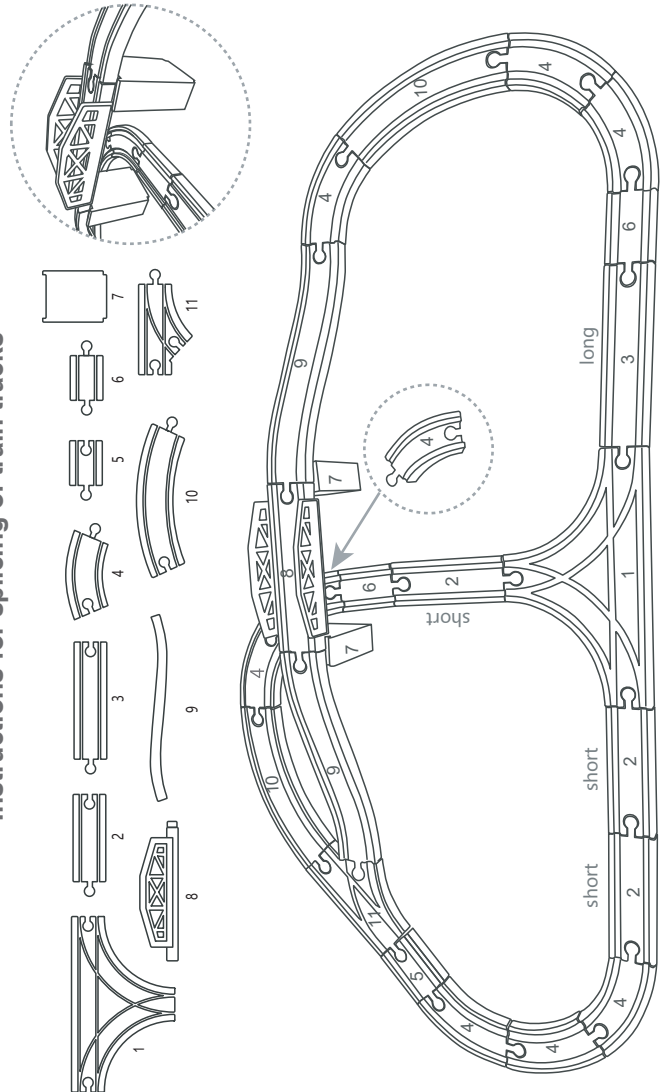

Instructions

Standard Assembly + Stickers

Assemble the tracks as shown in the diagram, place the desired stickers at the selected locations, turn on the robot train, and switch to Track mode by pressing the A key. Then, put the train on the track. The train will execute the corresponding instructions after it detects the color information. Pay attention to stickers' location.

Notice for all the stickers usage is as follows:

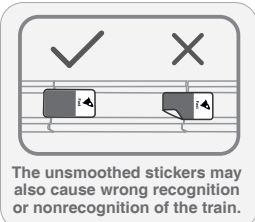
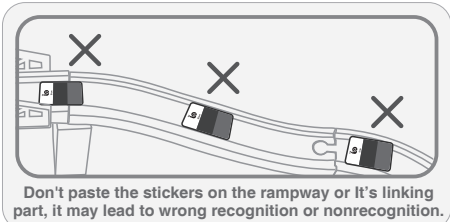

The distance between two stickers can't be too close, the short distance may lead to the wrong recognition.

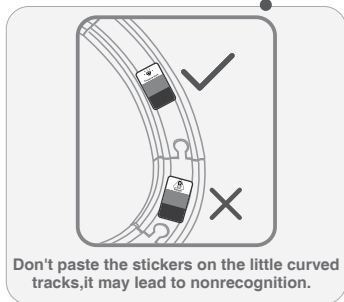
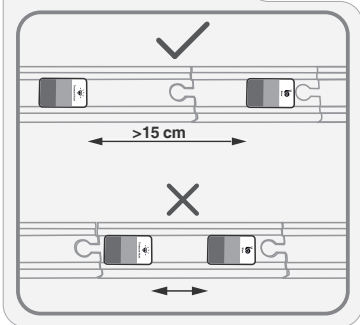

Notice for the turning stickers is as follows:

① Please paste the turn left sticker and the turn right or go straight sticker in the middle of the straight track that connects to the T track, allowing the train to turn left or go straight on the T track.

② Please paste the turn right sticker and the turn right or go straight sticker in the middle of the straight track that connects to the T track, allowing the train to turn right or go straight on the T track.

③ Paste the turn left or turn right sticker in the middle of the straight track that connects with the T track to make the train turn left or right at the T track.

④ Paste the turn around sticker on the straight track that connects with the T track to make the train turn around at the T track.

Notice for the turning stickers is as follows:

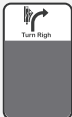
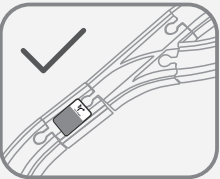

 Paste the turn right sticker on the straight track that connects with the Y track to make the train turn right at the Y track.

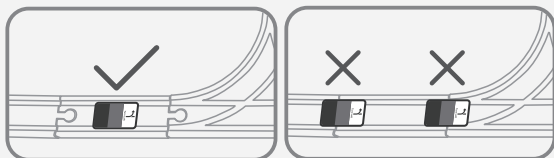
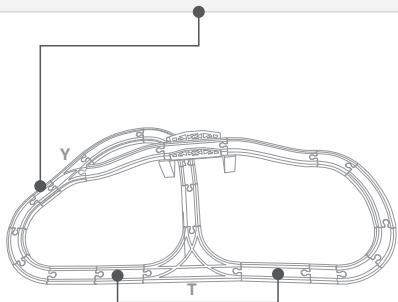
⑤



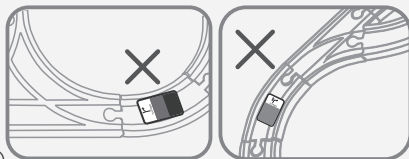







Don't paste the turning stickers on the curved track that connects to the T/Y track, the train may fail to turn.



If you want to build other molds of train track. Don't paste the turning stickers too near or too far, otherwise, it may cause the incorrect recognition.

⑥

Stickers Description:

 Go straight or turn right	 Go straight or turn left	 Turn left or turn right	 Turn around at the T track
 Turn right at the Y track	 Stop for a few seconds	 Turn right	 Turn left
 Fast	 Slow	 Reverse then go straight	 Gain treasure and accelerate
 Stop and flee away from the lion	 Leisure music	 Pop music	 Wandering
 Back and forth	 Police sound effect	 Ambulance sound effect	

Instructions

Freestyle Assembly + Stickers

Use track parts to form a freestyle construction, turn on the train and switch it to Track mode by pressing the A key. Then, put the robot train on the track, and place stickers on the track to control the robot train's operation.

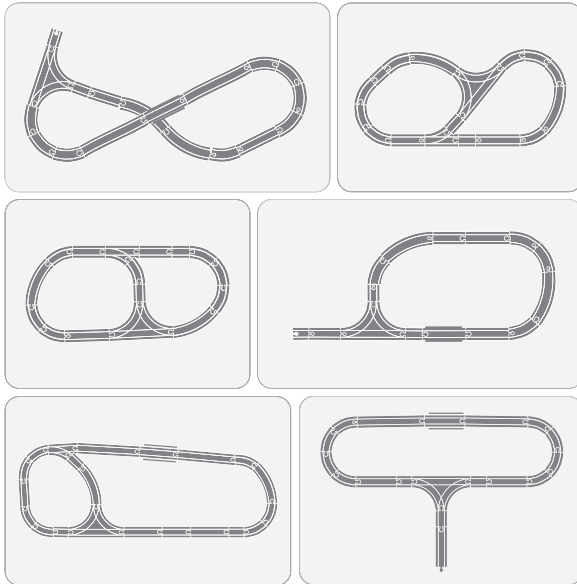

More

10

Instructions

2.Free Mode

In this mode, the robot train can be played with on a flat surface in two interactive ways: intelligent obstacle avoidance and intelligent tracking.

Intelligent Tracking

Press the on/off button and then press the B key to enter Place your hands or other objects in front of the robot train and the robot train will automatically follow them.

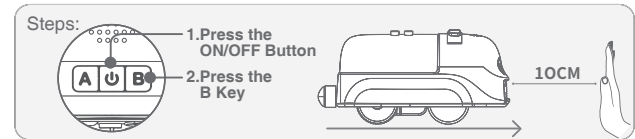

Intelligent Obstacle Avoidance

Press the B key again, or press the B key twice consecutively after starting the robot train, to enter into the tracking state.

Place your hands or other moving objects in front of the robot train and the robot train will automatically back up to avoid them.

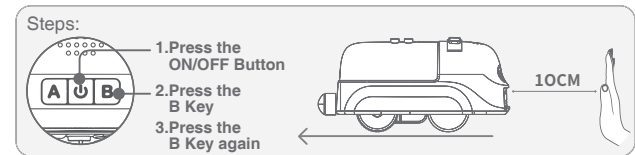

11

Instructions

3.Other Styles of Gameplay

Whistling

The robot train can react to whistle sound in any mode. The robot train will move forward in any mode. If the robot train is in an idle state, you can make it move forward by means of a whistle; if it is already in a state of movement, a whistle can accelerate the robot train for a certain distance.

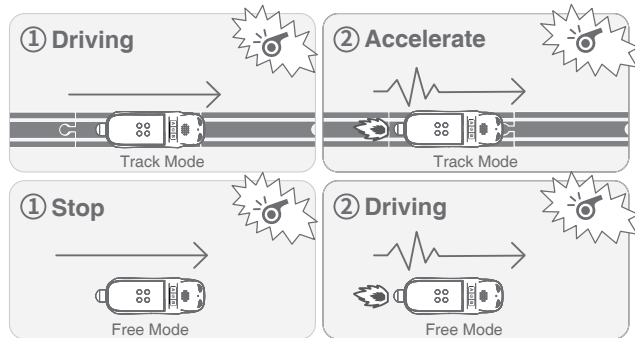

The whistle should purchase by yourself, please choose the plastic whistle with nucleus, and frequency between 2k to 2.5k. Refer to the following.



Compatible with Mainstream Block and Track

The robot train is compatible with mainstream blocks and wooden tracks, so that children can use it to create additional styles of gameplay.

Note: These alterations may affect the precision of its steering and the smoothness of its operation.

Product Specifications

Product name: Coding Express

Product model: RB-00010

Weight: 1.2KG

Material: PC+ABS, Beech

Power supply: Three No.7 [AAA] batteries;
supports rechargeable batteries

Operating time: 2 hours on a full charge

Operating temperature: 0°C-40°C

Firmware Update

Find out more ways to play, please upgrade the program through the connection between the Micro USB cable and the computer. Address for program and operational guide: www.robobloq.com/support/download

FAQ

1. Is it compatible with mainstream wooden tracks in the market?

Yes. However, you are not advised to replace the T-shaped tracks and Y-shaped tracks with products of other brands, while other track accessories are not subject to this restriction.

2.Can Coding Express carry a small vehicle?

Yes, we can, but we suggest you to carry with only one additional small vehicle, an excessive numbers of vehicles or overlong products may affect the life expectancy and steering performance of the product.

3.Will it continue to operate if I don't turn off the robot train?

In order to save energy, it will automatically shut down 30 minutes after startup.

4.Why does the color recognition and executive of the train go invalid after a period of time usage? And the train light will turn red?

After around two hours'duration of new batteries, the decreased electric tension will affect the train's recognition and executive function. Please replace the battery timely, otherwise, the train will continue to operate until the signal light turns red. The battery with poor quality may also shorten the duration performance.

5. Why will the train respond though there is no subject in front of it under the free mode in the day?

The natural light outside the window will also interrupt the working of sensor at the front of the train, please do not put the train head to the window directly when you play under the free mode in the day.

Safety & Usage Precautions

- 01 Please place the track on a flat surface, the operation on uneven surface may affect the turning function of the product.
- 02 Don't jam the drive wheels; otherwise, the device may be damaged.
- 03 Dirty color sensors and wheels may cause problems with operation and recognition.
- 04 Don't play with the robot train on the floor or a dirty surface; otherwise, it may affect the product's performance.
- 05 When the robot train and tracks are dirty, please wipe them out with a clean cloth.
- 06 Keep water away from the tracks, so as to avoid bending and deformation, which may affect assembly and operation. The train is not allowed put in the water, otherwise, it may operate abnormally and shorten its life expectancy, especially for the USB port and the battery area, the water may affect the safety issue of the product.
- 07 Don't force or pull out the rear magnet with tools.
- 08 The product is not equipped with batteries.
- 09 To ensure high performance and an enjoyable gaming experience, we suggest you to use batteries with good quality, please choose high-capacity alkaline batteries, Such as Ni-MH rechargeable batteries, or AAA lithium batteries. the batteries should be installed in a correct way, different types and endurance of batteries are not allowed to have a mix use, and the power supply side can not be short circuit.
- 10 Please take the chargeable batteries out to charge the batteries, don't charge the train directly through the USB

Safety & Usage Precautions

port. Non-rechargeable battery is forbade to be charged. Please take out the batteries under the shutdown mode and the process of removing and the rechargeable battery needed to be recharged under adult's supervision.

- 11 Please take the exhausted batteries out of the train.
- 12 The strong light on the bottom of the product may be harmful to your eyes. Please do not stare at the light directly.
- 13 Please store the product in proper place when it will not be used for an extended period of time.
- 14 To make sure that the train could have a correct recognition to the stickers, please paste the stickers along with the direction of the train tracks smoothly and avoid to paste on the connecting parts.
- 15 To guarantee the stickers can be recognized correctly, please avoid to paste them at the slope or turning position.
- 16 An excessive numbers, weight, length (more than 7 cm) of vehicles could influence the normal operation of the products.
- 17 Please keep a more than 15 cm distance between each sticker, the wrong recognition or nonrecognition situation may appear if two stickers are too close.
- 18 Please take care of your product and do not treat it violently, it may lead to damage of toy.
- 19 An excessive numbers of blocks that put on the top of the train could affect the turning and climbing function.
- 20 Except for the sales wooden track carriages and maintream spliced blocks, do not drag or carry other heavy products, it may cause the damage of product.

FCC Certification

This device complies with part 15 of the FCC rules. Operation is subject to the following two conditions: (1) This device may not cause harmful interference, and(2) this device must accept any interference received, including interference that may cause undesired operation.

Manufacturer: Robobloq Co., Ltd. Made in China
Model No.: RB-00010

RoHS FC CE 



About Robobloq

Robobloq, located in Shenzhen, is a national-level high-tech enterprise that dedicates to the research and development of global educational technology products and artificial Intelligence. The company regards the artificial intelligence as core technology, motivated by creativity, put customer's experience in the first place, aims to become an international leading brand that develops intelligent robots applied to both family educational entertainment and school teaching. Currently, under Robobloq's brand, we have brought out various product series including metal educational products such as Qoopers, Q-Scout, innovative educational products such as Qobo, satisfying the growth and learning needs of children from the aged group of 3 to 18. Robobloq's products were sold to more than 50 countries and regions both at home and overseas. Meanwhile, Robobloq has gained hundreds of thousands of customer's recognition and support.

Vision: be a respectable high-tech enterprise.